

BJ Series

Compact and Long sensing distance

■ Features

■ Long distance sensing type

- Long sensing distance with high quality lens
- Long sensing distance
 - : Through-beam type 15m, Diffuse reflective type 1m,
 - Polarized retroreflective type 3m(MS-2A)
- M.S.R.(Mirror Surface Rejection) function (Polarized retroreflective type)
- Compact size: W20×H32×L10.6mm
- Protection structure IP65/IP67(IEC standard)
- Light ON/Dark ON selectable
- Sensitivity adjustment VR incorporated
- Built-in reverse power polarity, output short, overcurrent protection circuit
- Mutual interference prevention function (Except through-beam type)
- Improved noise resistance and minimize effect of inverter disturbance light

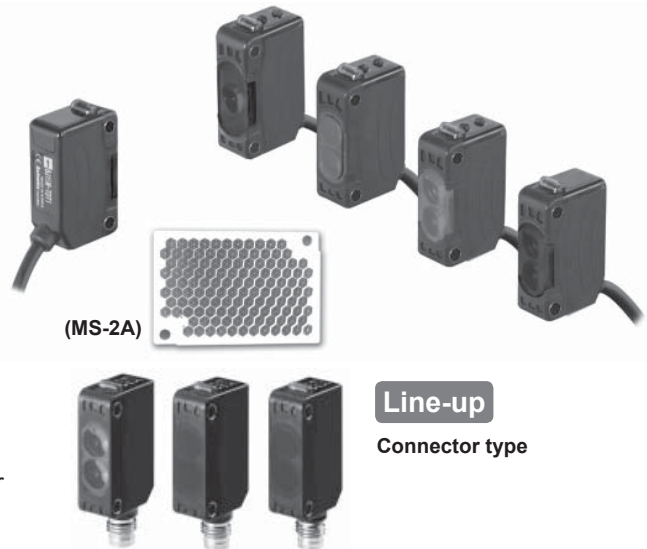

⚠ Please read "Caution for your safety" in operation manual before using.



■ Specifications

※The model name with '-C' is connector type.

Type		Long distance sensing type						
Model	NPN open collector output	BJ15M-TDT BJ15M-TDT-C	BJ10M-TDT BJ10M-TDT-C	BJ7M-TDT	BJ3M-PDT BJ3M-PDT-C	BJ1M-DDT BJ1M-DDT-C	BJ300-DDT BJ300-DDT-C	BJ100-DDT BJ100-DDT-C
	PNP open collector output	BJ15M-TDT-P BJ15M-TDT-C-P	BJ10M-TDT-P BJ10M-TDT-C-P	BJ7M-TDT-P	BJ3M-PDT-P BJ3M-PDT-C-P	BJ1M-DDT-P BJ1M-DDT-C-P	BJ300-DDT-P BJ300-DDT-C-P	BJ100-DDT-P BJ100-DDT-C-P
Sensing type		Through-beam			Polarized retroreflective	Diffuse reflective		
Sensing distance		15m	10m	7m	0.1 to 3m ^{※1} (MS-2A)	1m (Non-glossy white paper 300×300mm)	300mm (Non-glossy white paper 100×100mm)	100mm (Non-glossy white paper 100×100mm)
Sensing target		Opaque material over ø12mm		Opaque material over ø8mm	Opaque material over ø75mm	Translucent, opaque materials		
Hysteresis		—						
Response time		Max. 1ms						
Power supply		12-24VDC±10%(Ripple P-P: Max.10%)						
Current consumption		Emitter/Receiver: Max. 20mA			Max. 30mA			
Light source		Infrared LED (850nm)	Red LED (660nm)	Red LED (650nm)	Red LED (660nm)	Infrared LED (850nm)	Red LED (660nm)	Infrared LED (850nm)
Sensitivity adjustment		Built-in the adjustment VR						
Operation mode		Light ON/Dark ON selectable						
Control output		NPN or PNP open collector output ●Load voltage: Max. 26.4VDC ●Load current: Max. 100mA ●Residual voltage - NPN: Max. 1V, PNP: Min. 2.5V						
Protection circuit		Reverse polarity protection, output short-circuit protection, interference prevention function(Except through-beam type)						
Indicator		Operation: Red, Stable: Green(Emitter's power indicator: Green)						
Insulation resistance		Max.20MΩ(at 500VDC megger)						
Dielectric strength		1000VAC 50/60Hz for 1minute						
Vibration		1.5mm or 300m/s ² amplitude at frequency of 10 to 55Hz(for 1 min.) in each of X, Y, Z directions for 2 hours						
Shock		500m/s ² in each of X, Y, Z directions for 3 times						
Environ-ment	Ambient illumination	Sunlight: Max. 11,000lx, Incandescent lamp: Max. 3,000lx(Receiver illumination)						
	Ambient temperature	-25 to 55°C, storage: -40 to 70°C						
	Ambient humidity	35 to 85%RH, storage: 35 to 85%RH						
Protection		BJ - IP65(IEC standard), BJ-C - IP67(at non-dew status)						
Material		Case: PC+ABS, LED Cap: PC, Sensing part: PMMA						
Cable ^{※2}		BJ: ø3.5mm, 3-wire, Length: 2m(Emitter of through-beam type: ø3.5mm, 2-wire, Length: 2m) (AWG24, Core diameter: 0.08mm, Number of cores: 40, Insulator out diameter: ø1mm)						
Accessory	Common	Mounting bracket, Bolt, Nut, VR adjustment driver						
	Individual	—			Reflector(MS-2A)	—		
Approval		CE						
Unit weight		BJ: Approx. 90g, BJ-C: Approx. 20g			BJ: Approx 60g BJ-C: Approx 30g	BJ: Approx. 45g, BJ-C: Approx. 10g		

※1: The sensing distance is extended to 0.1 to 4m or 0.1 to 5m when using optional reflector MS-2S or MS-3S.

※2: M8 connector cable is sold separately. (Cable - AWG22, Core diameter: 0.08mm, Number of cores: 60, Insulator out diameter: 1.25mm)

※ The temperature or humidity mentioned in Environment indicates a non freezing or condensation environment.

Long sensing distance/BGS reflective/Micro spot type

Transparent glass sensing/BGS reflective/Micro spot type

■ Features

■ BGS reflective type

- Adopts BGS method superior than convergent reflective to minimize error by background, or color, material of sensing object for stable sensing by adjusting the volume
- Visible light source to check the position of sensing spot and small spot minimizing effect of the ambient objects with narrow sensing width

■ Transparent glass sensing type / Micro spot type

- Stable sensing for transparent object(LCD, PDP, glass etc) by BJG30-DDT
- Easy to check sensing location with visible micro spot(BJN Series)
- Detects tiny objects (min. sensing target $\varnothing 0.2\text{mm}$ copper wire)

■ Commonness

- Compact size: W20×H32×L10.6mm
- Protection structure IP65(IEC standard)
- Light ON/Dark ON selectable(Except BJG30-DDT)
- Sensitivity adjustment VR incorporated(Except BJG3 DDT)
- Built-in reverse power polarity, output short, overcurrent protection circuit
- Mutual interference prevention function(Except BGS reflective type)
- Improved noise resistance and minimized effect of inverter disturbance light

 Please read "Caution for your safety" in operation manual before using.



■ Specifications

Type	Transparent glass sensing type	BGS reflective type			Micro spot type		
Model	NPN open collector output BJG30-DDT	BJ30-BDT	BJ50-BDT	BJ100-BDT	BJN50-NDT	BJN100-NDT	
Model	PNP open collector output —	BJ30-BDT-P	BJ50-BDT-P	BJ100-BDT-P	BJN50-NDT-P	BJN100-NDT-P	
Sensing type	Diffuse reflective		BGS reflective			Narrow beam reflective	
Sensing distance	30mm (Non-glossy white paper 100×100mm)	15mm (Transparent glass 50×50mm, t=3.0mm)	10 to 30mm (Non-glossy white paper 50×50mm)	10 to 50mm (Non-glossy white paper 50×50mm)	10 to 100mm (Non-glossy white paper 100×100mm)	30 to 70mm	70 to 130mm
Sensing target	Transparent glass, opaque materials, translucent		Translucent, opaque materials			Translucent, opaque materials	
Min. diameter of transmitting SPOT	—		Approx. $\varnothing 5.0\text{mm}$	Approx. $\varnothing 4.5\text{mm}$	Approx. $\varnothing 6.5\text{mm}$	Approx. $\varnothing 2.0\text{mm}$	Approx. $\varnothing 2.5\text{mm}$
Min. sensing target	—		—			Approx. min. $\varnothing 0.2\text{mm}$ (Copper wire)	
Hysteresis	Max. 20% at sensing distance		Max. 10% at sensing distance			Max. 25% at sensing distance	Max. 20% at sensing distance
Response time	Max. 1ms		Max. 1.5ms			Max. 1ms	
Power supply	12-24VDC $\pm 10\%$ (Ripple P-P: Max.10%)						
Current consumption	Max. 30mA						
Light source/Wavelength	Infrared LED(850nm)		Red LED(660nm)			Red LED(650nm)	
Sensitivity adjustment	—		Built-in the adjustment VR				
Operation mode	Light ON fixed		Light ON / Dark ON selectable				
Control output	NPN open collector output •Load voltage: Max. 26.4VDC •Load current: Max.100mA •Residual voltage: Max. 1V		NPN or PNP open collector output •Load voltage: Max. 26.4VDC •Load current: Max. 100mA •Residual voltage - NPN: Max. 1V, PNP: Min. 2.5V				
Protection circuit	Reverse polarity protection, output short-circuit protection, interference prevention function(Except BGS reflective type)						
Indicator	Operation indicator: Red, Stability indicator: Green						
Insulation resistance	Min. 20M Ω (at 500VDC megger)						
Dielectric strength	1,000VAC 50/60Hz for 1minute						
Vibration	1.5mm or 300m/s ² amplitude at frequency of 10 to 55Hz(for 1 min.) in each of X, Y, Z directions for 2 hours						
Shock	500m/s ² in each of X, Y, Z directions for 3 times						
Environment	Ambient illumination	Sunlight: Max. 11,000lx, Incandescent lamp: Max. 3,000lx(Receiver illumination)					
	Ambient temperature	-25 to 55°C, storage:-40 to 70°C					
	Ambient humidity	35 to 85%RH, storage: 35 to 85%RH					
Protection	IP65(IEC standard)						
Material	Case: PC+ABS, LED Cap: PC, Sensing part: PMMA						
Cable	$\varnothing 3.5\text{mm}$, 3-wire, Length: 2m(AWG24, Core diameter: 0.08mm, Number of cores: 40, Insulator out diameter: $\varnothing 1\text{mm}$)						
Accessory	Mounting bracket, Bolt		Mounting bracket, Bolt, Adjustment driver				
Approval	CE						
Unit weight	Approx. 45g		Approx. 50g			Approx. 45g	

※ The temperature or humidity mentioned in Environment indicates a non freezing or condensation environment.

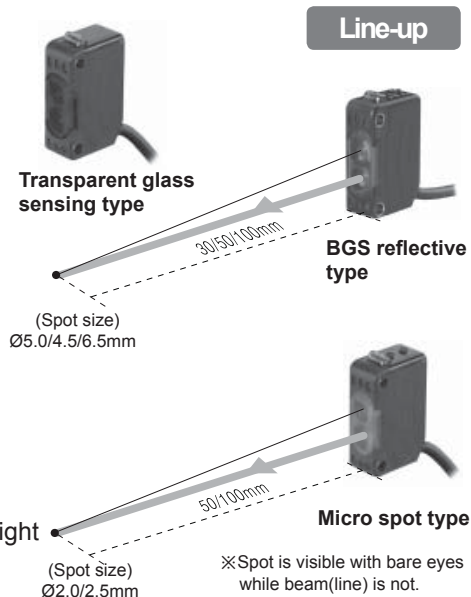

(A) Photo electric sensor

(B) Fiber optic sensor

(C) Door/Area sensor

(D) Proximity sensor

(E) Pressure sensor

(F) Rotary encoder

(G) Connector/Socket

(H) Temp. controller

(I) SSR/Power controller

(J) Counter

(K) Timer

(L) Panel meter

(M) Tacho/Speed/Pulse meter

(N) Display unit

(O) Sensor controller

(P) Switching power supply

(Q) Stepping motor& Driver&Controller

(R) Graphic/Logic panel

(S) Field network device

(T) Software

(U) Other

BJ Series

■ Feature data

◎ Through-beam type

- BJ15M-TDT-(C)-(P) / BJ10M-TDT-(C)-(P) / BJ7M-TDT-(P)

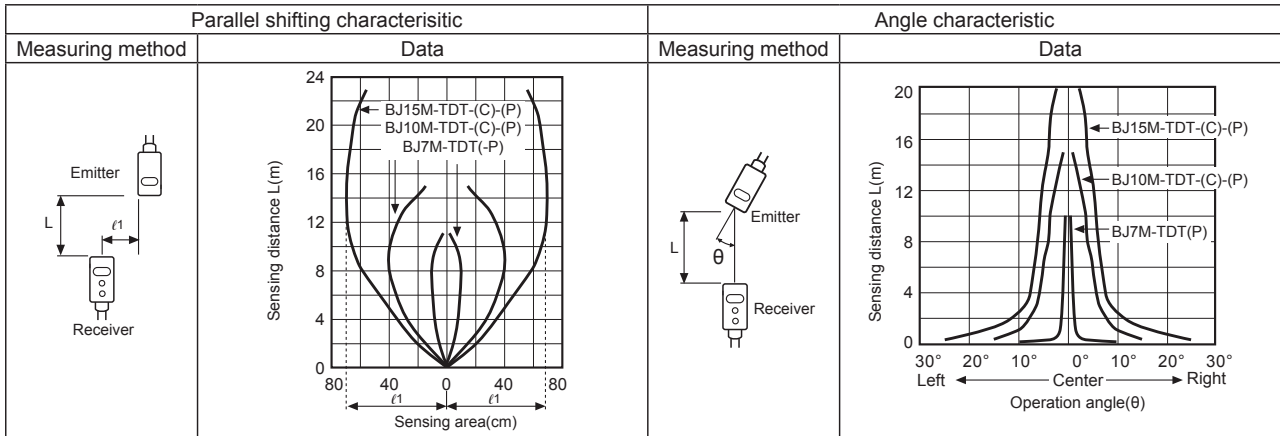

◎ Retroreflective type

- IBJ3M-PDT-(C)-(P)

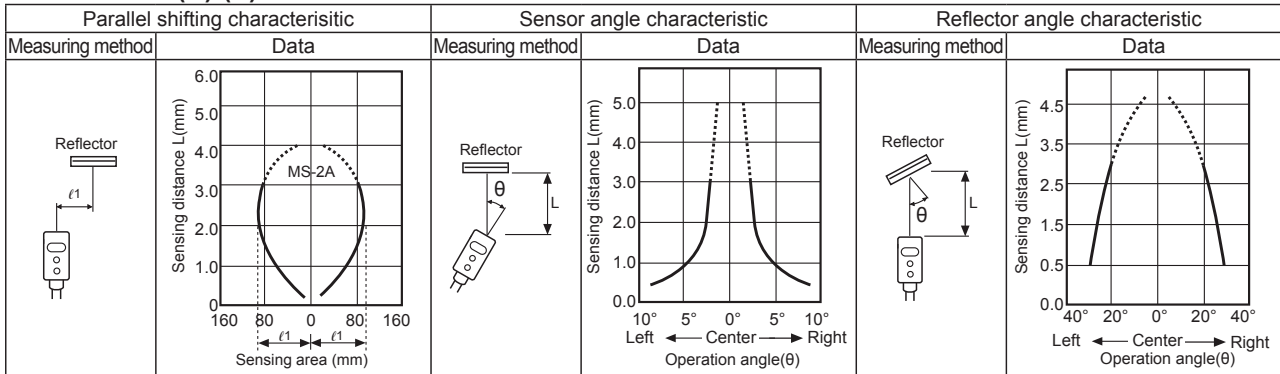

◎ Diffuse/Narrow beam reflective type

- BJ1M-DDT-(C)-(P)

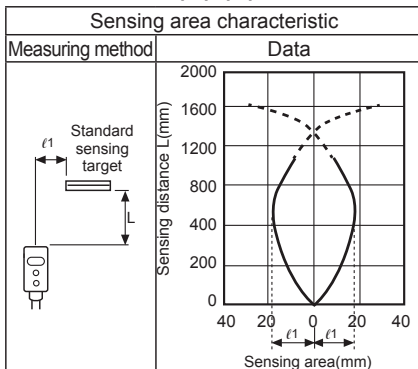

- BJ300-DDT-(C)-(P)

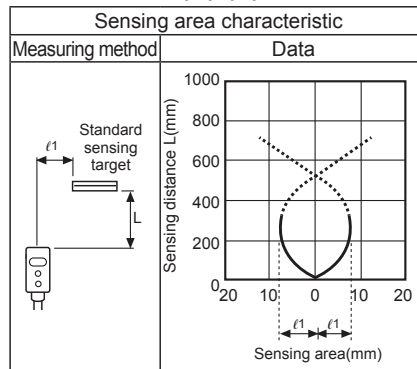

- BJ100-DDT-(C)-(P)

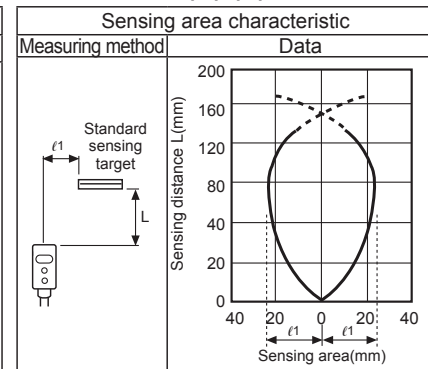

- BJG30-DDT

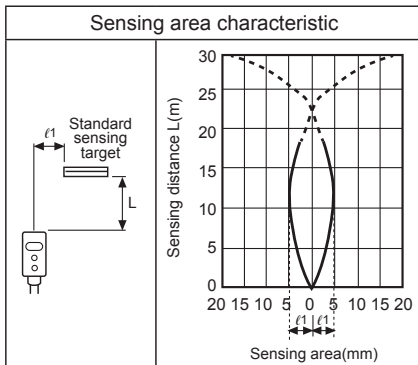

- BJNI50-NDT-(P)

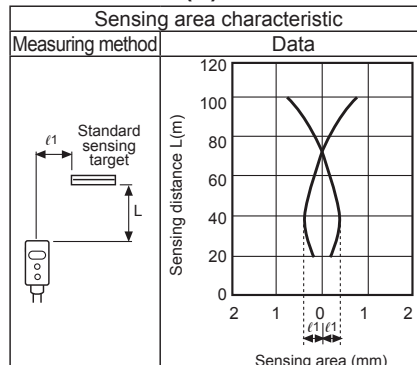

- BJNI100-NDT-(P)

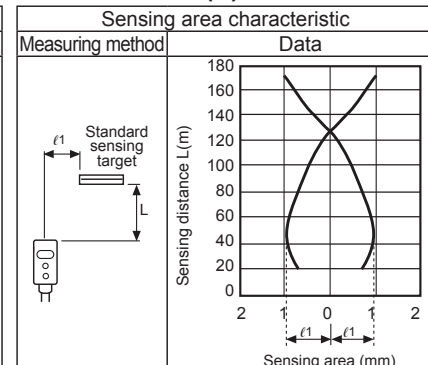

Long sensing distance/BGS reflective/Micro spot type

Feature data

◎ BGS reflective type

● BJ30-BDT / BJ30-BDT-P

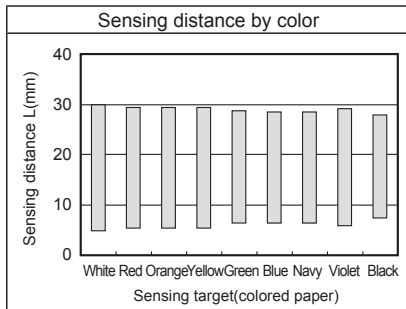
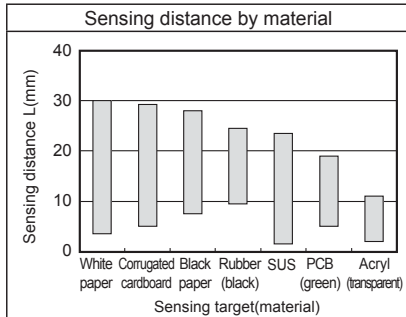
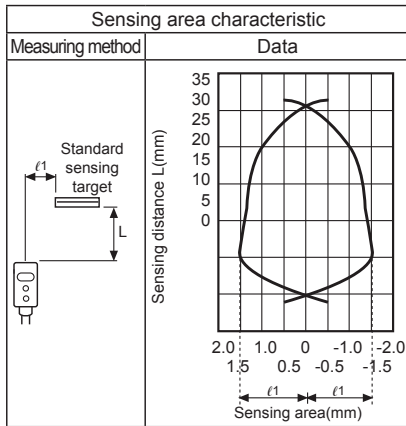

● BJ50-BDT / BJ50-BDT-P

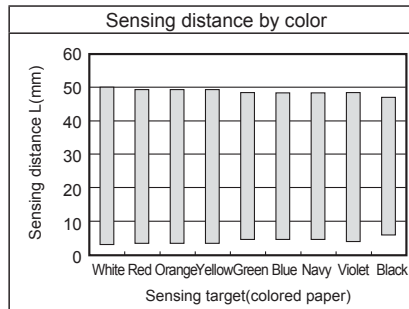
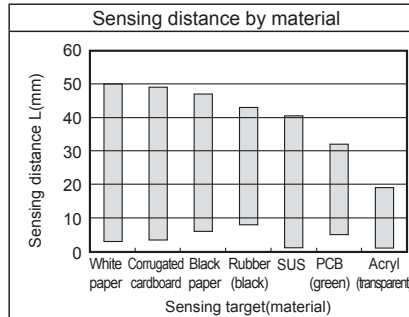
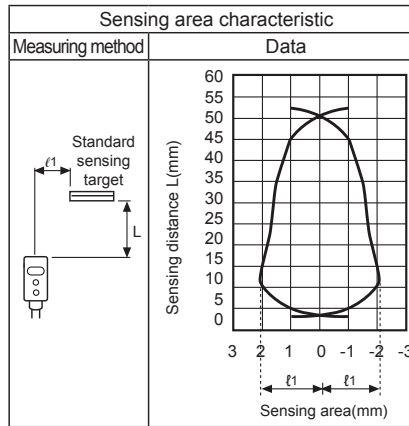

● BJ100-BDT / BJ100-BDT-P

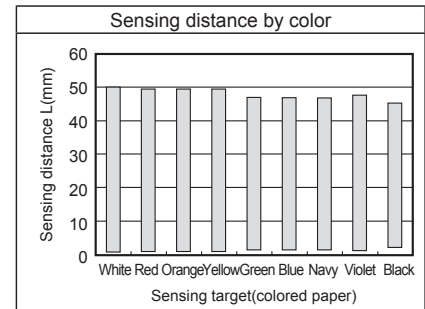
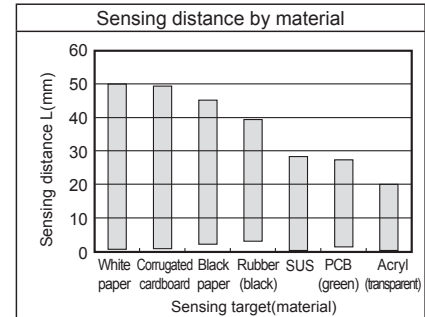
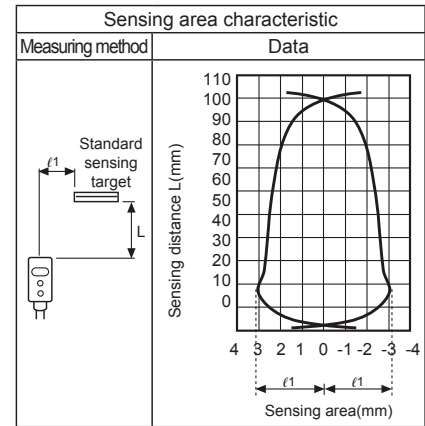

- (A) Photo electric sensor
- (B) Fiber optic sensor
- (C) Door/Area sensor
- (D) Proximity sensor
- (E) Pressure sensor
- (F) Rotary encoder
- (G) Connector/Socket
- (H) Temp. controller
- (I) SSR/Power controller
- (J) Counter
- (K) Timer
- (L) Panel meter
- (M) Tacho/Speed/Pulse meter
- (N) Display unit
- (O) Sensor controller
- (P) Switching power supply
- (Q) Stepping motor& Driver&Controller
- (R) Graphic/Logic panel
- (S) Field network device
- (T) Software
- (U) Other

Connections

● Through-beam type

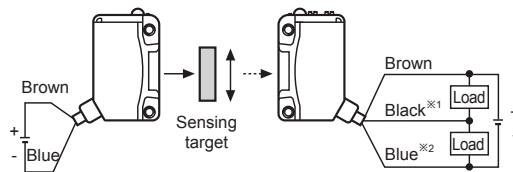

※1: The load connection of NPN open collector output
 ※2: The load connection of PNP open collector output

● Retroreflective type

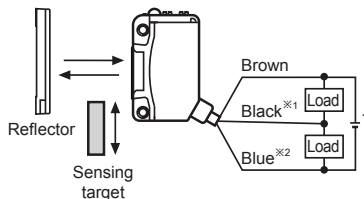

● Diffuse/Narrow beam/BGS reflective type

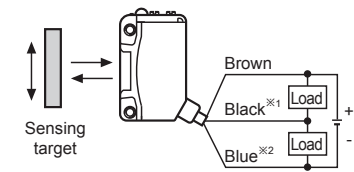

Connections for connector part

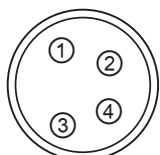

M8 Connector pin

Connector pin No.	Cable colors	Function
①	Brown	Power Source(+V)
②	White	—
③	Blue	Power Source(0V)
④	Black	Output

※ Connector pin ② is N-C(Not Connected) terminal.

● Connector cable(sold separately)

※ Connector cable model : CID408-□, CLD408-□
 ※ Please refer to G-6 for connector cable.

BJ Series

Control output diagram

NPN open collector output

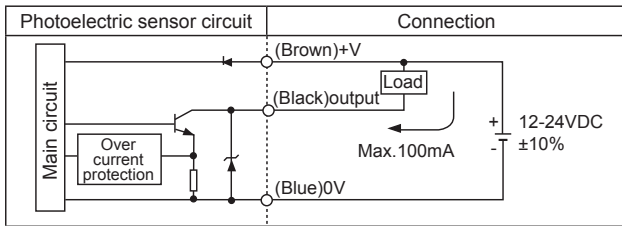

PNP open collector output

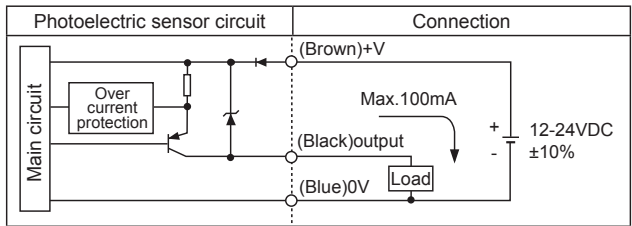

Operation mode

Operation mode	Light ON	Dark ON
Receiver operation	Received light Interrupted light	Received light Interrupted light
Operation indicator (red LED)	ON OFF	ON OFF
Transistor output	ON OFF	ON OFF

Dimensions

(unit: mm)

Through-beam type

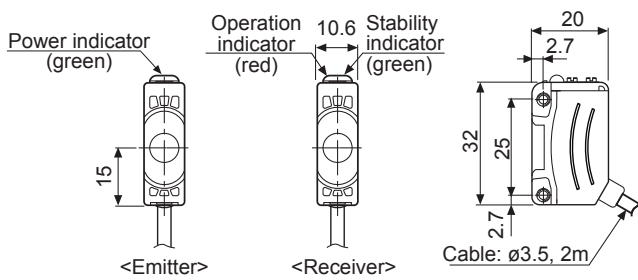

Through-beam type(Connector type)

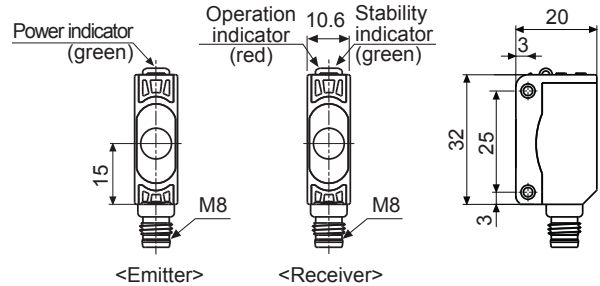

Retroreflective type

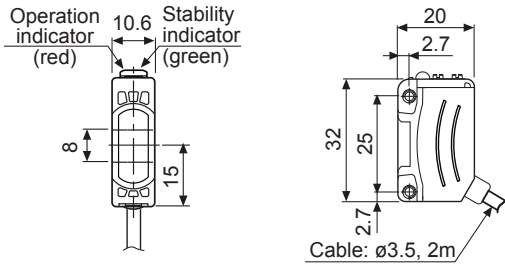

Retroreflective type(Connector type)

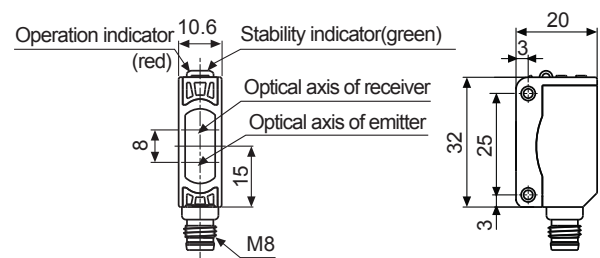

Diffuse/Narrow beam/BGS reflective type - Connect the bracket A

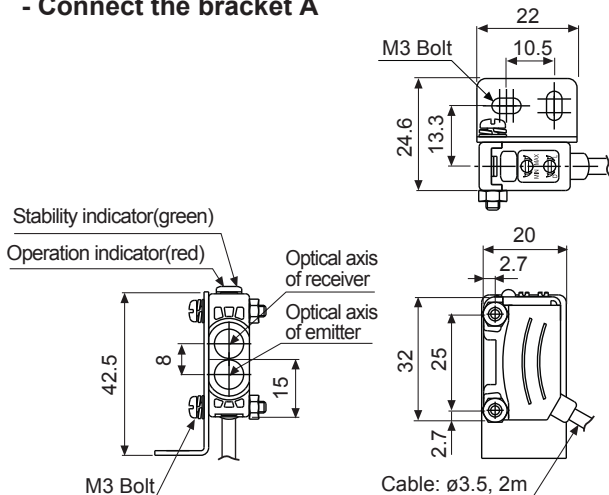

Diffuse reflective type(Connector type) - Connect the bracket B

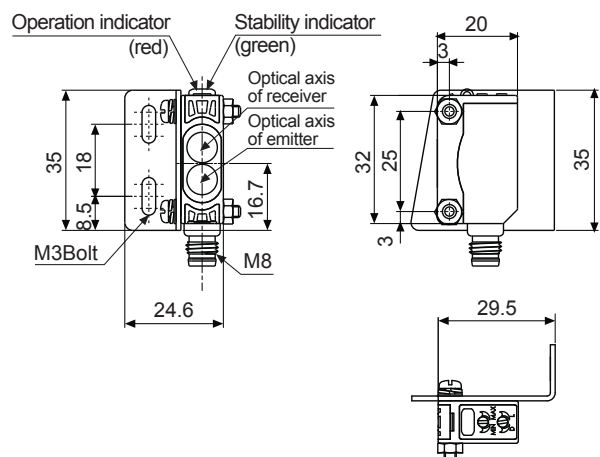

Long sensing distance/BGS reflective/Micro spot type

● Reflector

(accessory:MS-2A,
sold separately:MS-2S, MS-3S)

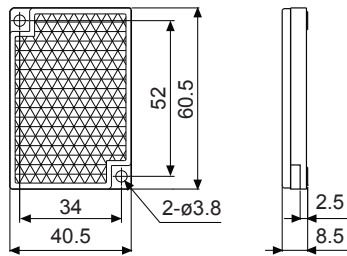

● Bracket A

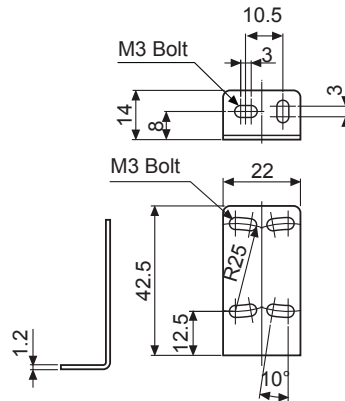

● Bracket B(sold separately)

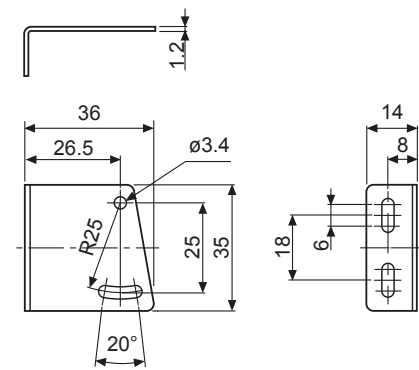

■ Operation timing diagram

● Through-beam type

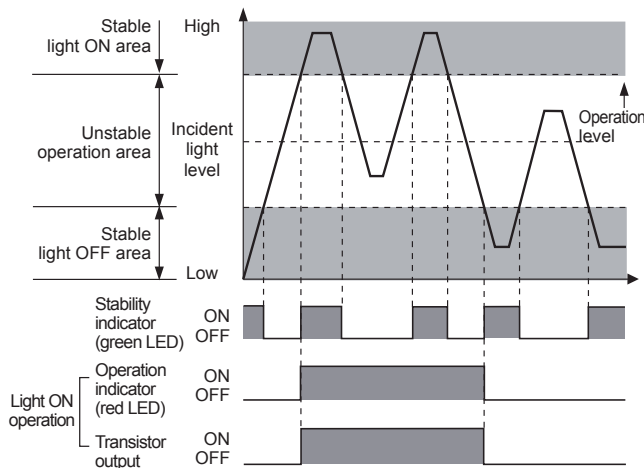

● Diffuse/Narrow beam/BGS reflective type

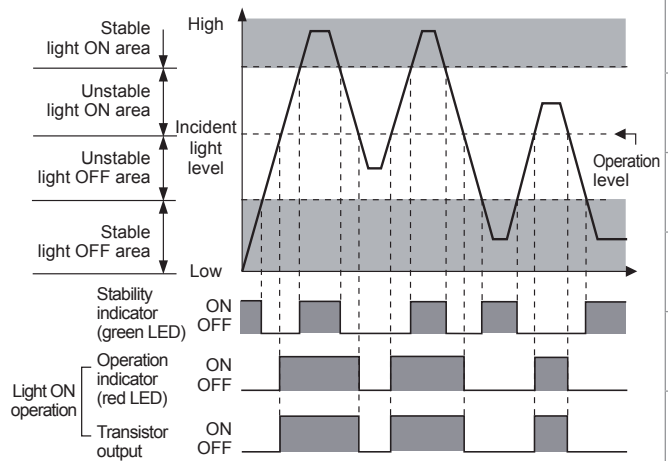

※The waveforms of “Operation indicator” and “Transistor output” are for Light ON operation.
They are opposite operation for Dark ON operation.

■ Mounting and sensitivity adjustment

◎ For mounting

Please use bolts M3 for mounting of sensor, set the tightening torque under 0.5N·m.

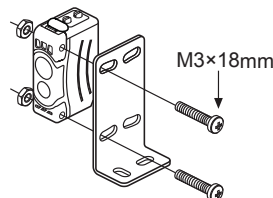

◎ Switching of operation mode

Light ON operation		Turn the switching volume of operation mode to end of right(L direction), it is set as Light ON.
Dark ON operation		Turn the switching volume of operation mode to end of left(D direction), it is set as Dark ON.

※ For through-beam type, the switching volume of operation mode is built-in the receiver.

◎ Optical axis adjustment

● Through-beam type

- Place the emitter and the receiver facing each other and supply the power.
- After adjusting the position of the emitter and the receiver and check their stable indicating range, mount them in the middle of the range.
- After mounting this unit, check the operation of the sensor and lighting of the stability indicator in both status. (None or sensing target status)

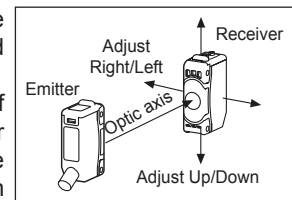

- After mounting this unit, check the operation of the sensor and lighting of the stability indicator in both status. (None or sensing target status)

※ When the sensing target is translucent or small(under sensing target of ' ■ Specifications'), it may not be detected by the sensor because the light can penetrate it.

(A) Photo electric sensor

(B) Fiber optic sensor

(C) Door/Area sensor

(D) Proximity sensor

(E) Pressure sensor

(F) Rotary encoder

(G) Connector/Socket

(H) Temp. controller

(I) SSR/Power controller

(J) Counter

(K) Timer

(L) Panel meter

(M) Tacho/Speed/ Pulse meter

(N) Display unit

(O) Sensor controller

(P) Switching power supply

(Q) Stepping motor& Driver&Controller

(R) Graphic/ Logic panel

(S) Field network device

(T) Software

(U) Other

BJ Series

• Retroreflective type

1. Place the sensor and the reflector facing each other and supply the power.
2. After adjusting the position of the sensor and reflector and check their stable indicating range, mount them in the middle of the range. (None or sensing target status)
3. After mounting this unit, check the operation of the sensor and in both status. (None or sensing target status)

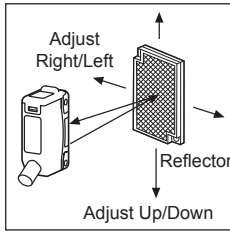

• Diffuse/Narrow beam/BGS reflective type

- After place a sensing target, adjust the sensor to up or down, right or left.
Then, fix the sensor in the center of position where the indicator is operating.

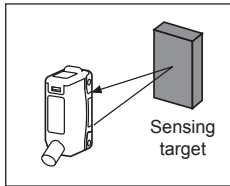

• Object(Copper wire) detection <Micro spot type>

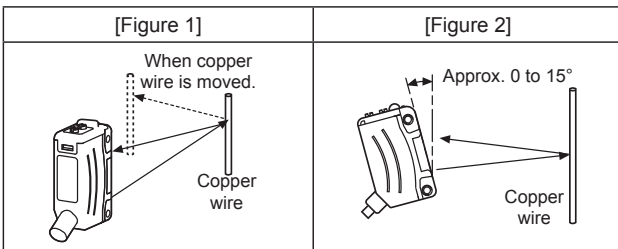

※Mount the sensor slanted at an angle ranged 0 to 15° shown above as [Figure 2] for stable detection to detect as shown in [Figure 1].

■ Sensitivity adjustment

Order	Position	Description
1	(A)	Turn the adjustment VR to the right of min. and check position(A) where the operation indicator is turned ON in "Light ON status".
2	(A) (B) (C)	Turn the adjustment VR more to the right of position(A), check position(B) where the operation indicator is turned ON. And turn the adjustment VR to the left, check position(C) where the operation indicator is turned OFF in "Light OFF status". ※If the operation indicator is not turned ON although the adjustment VR is turned to the max. position, the max. position is (C).
3	Optimal sensitivity (A) (C)	Set the adjustment VR at the center of (A) and (C). To set the optimum sensitivity, check the operation and lighting of stability indicator with sensing target or without it. If the stability indicator is not turned ON, please check the sensing method again because sensitivity is unstable.

※No sensitivity adjustment function available for BJG30-DDT models.

	Light ON status	Light OFF status
Through-beam type		
Retro-reflective type		
Diffuse/Narrow beam/BGS reflective		

※Set the sensitivity to operate in stable light ON area and the reliability for the environment (temperature, voltage, dust etc) is increased. In unstable light ON area, be sure that the variation of environment.

※Do not apply excessive force on the adjustment VR, it may be broken.